

HIGH POWER RESISTOR

S1BB150050

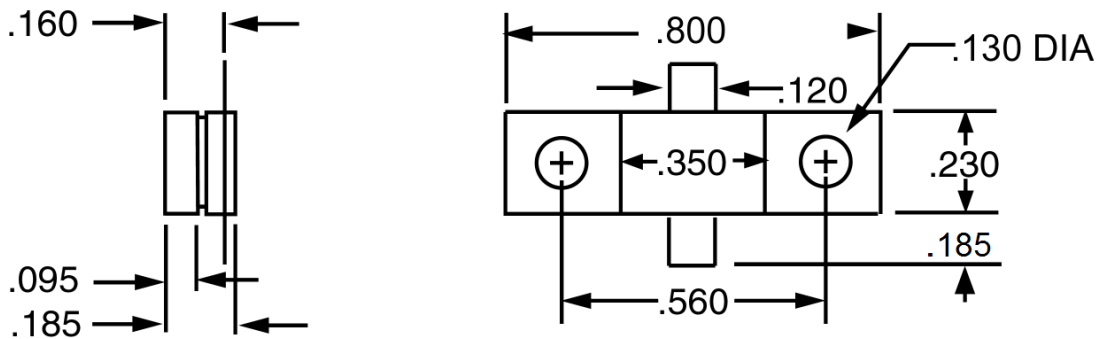

Electrical Specifications		Material Specifications		General Specifications	
RFT P/N	S1BB150050	Substrate	BeO	Mechanical Tolerance	±.010"
Power (Watt)	150	Flange	Copper with Nickel Plating	Resistance Tolerance	±5%
Resistance (Ohm)	50	Tab	Nickel with Silver plating	Power Handling	150 W @ 100°C 0 W @ 180°C
Frequency (GHz)	3	Cover	Alumina	Construction	Lead free solder
Capacitance (pF Typical)	1.5	Resistive Element	Thick Film	RoHS Compliance	Yes with Electronic exemption

All dimensions are in inches. 1% & 2% resistance tolerance available. Other resistance values available.

2245 Fortune Drive, San Jose, CA 95131 Phone: (408) 433-1941 Fax: (408) 433-1943

	CAGE CODE 0NR42	150W 50 Ohm Resistor	
		Dwg. No.:S1BB150050	Rev. B