

HIGH POWER BRAZED RESISTOR

1E100050

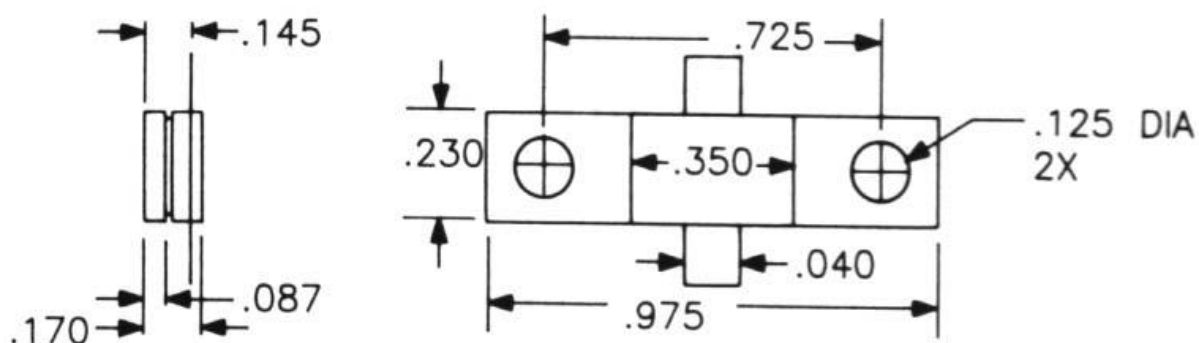

Electrical Specifications		Material Specifications		General Specifications	
RFT P/N	1E100050	Substrate	BeO	Mechanical Tolerance	±.010"
Power (Watt)	100	Flange	Copper with Nickel Plating	Resistance Tolerance	±5%
Resistance (Ohm)	50	Tab	Nickel with Silver plating	Power Handling	100 W @ 100°C 0 W @ 250°C
Frequency (GHz)	3	Cover	Alumina	Construction	Brazed
Capacitance (pF Typical)	1.8	Resistive Element	NiChrome	RoHS Compliance	Yes

All dimensions are in inches. Minimum lead length 0.125". 1% & 2% resistance tolerance available. Other resistance values available.

2245 Fortune Drive, San Jose, CA 95131 Phone: (408) 433-1941 Fax: (408) 433-1943

	CAGE CODE 0NR42	100w 50 Ohm Resistor	
		Dwg. No:1E100050	Rev. A